

REV	DESCRIPTION	DATE
A	Initial Release	07.09.21

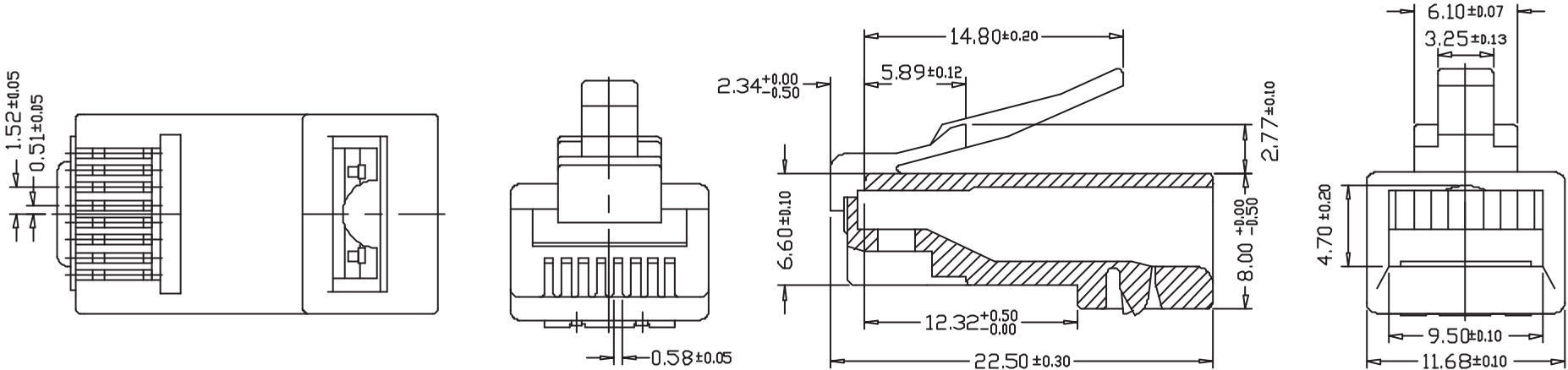

#C6E6 .GMP8P8C

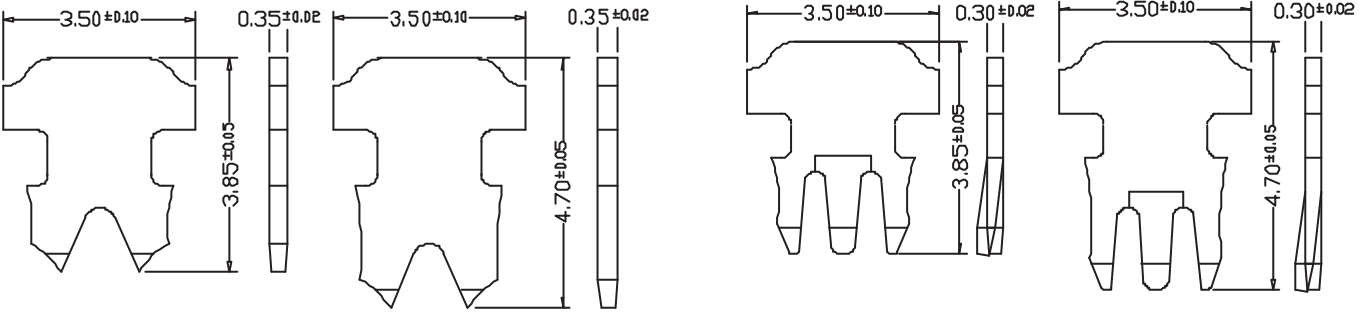

" " : 2 PRONGS FOR STRANDED WIRE

"3" : 3 PRONGS FOR SOLID WIRE(S)

PART NUMBER CODE:

MPC6 $\frac{R}{1}$ $\frac{02}{2}$ $\frac{U2}{3}$ $\frac{**}{4}$

- 1. R:ROUND CABLE F:FLAT CABLE
- 2. SKIP:2 PRONGS FOR STRANDED WIRES
02:2 PRONGS FOR SOLID WIRES
03:3 PRONGS FOR SOLID WIRES
- 3. U2:UL94V2, U0:UL-94V0 REATED
- 4. CONTACT GOLD PLATING:
03: 3u" 06:6u", 15:15u", 30:30u" 50:50u"

PANSTRONG COMPANY LTD.				DRAWN BY		TOMMY	
				CHECKED			
TITLE:				APPROVED			
PART NO:		MPC6		DRAW NO			
File Number:							
SCALE			REV	A	UNIT	mm	

REV	DESCRIPTION	DATE
A	Initial Release	07.09.21

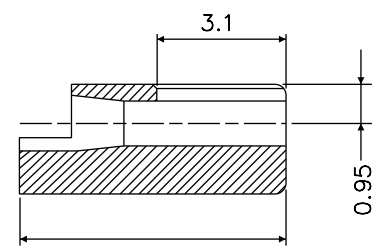
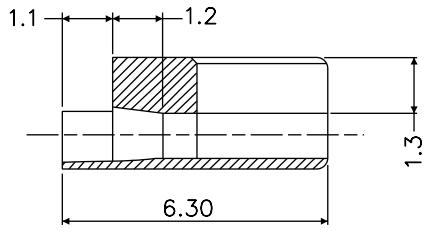
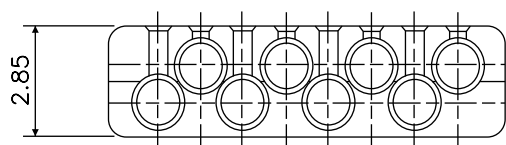
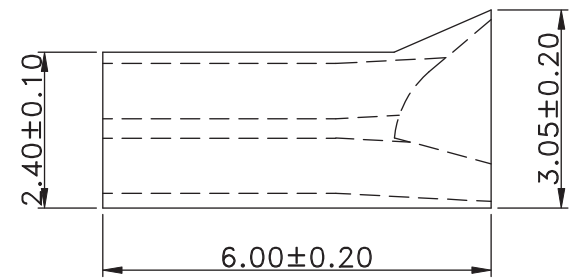
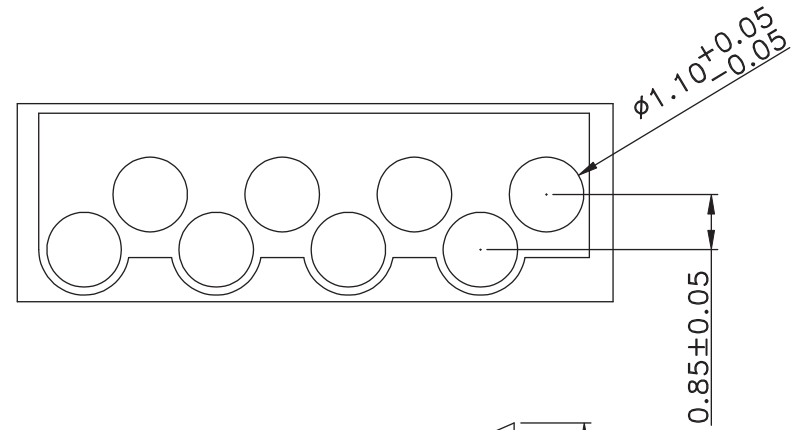
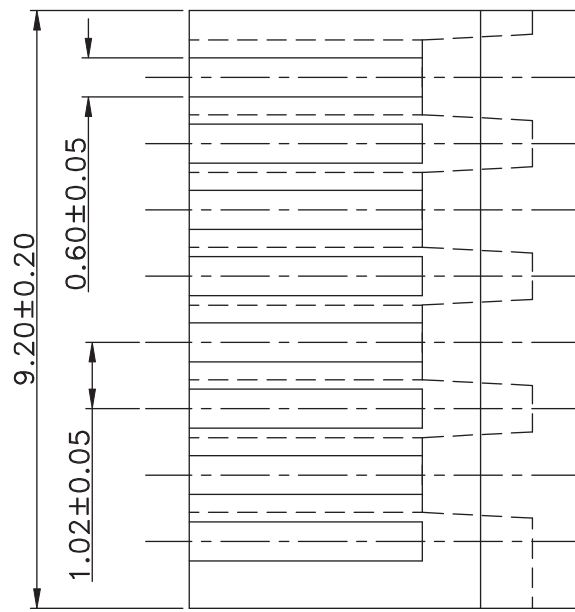
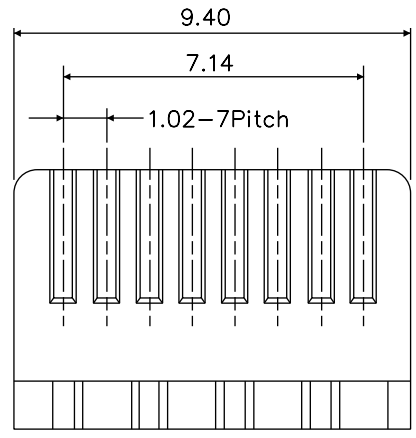

MATERIAL:
 1.Housing: Polycarbonate, UL 94V-2
 UL 94V-0

 PANSTRONG COMPANY LTD.	DRAWN BY	TOMMY
	CHECKED	
TITLE:		
PART NO:	MPC6	
File Number:		
SCALE	REV	A
UNIT	mm	