

REV	DESCRIPTION	DATE
A	Initial Release	07.09.21

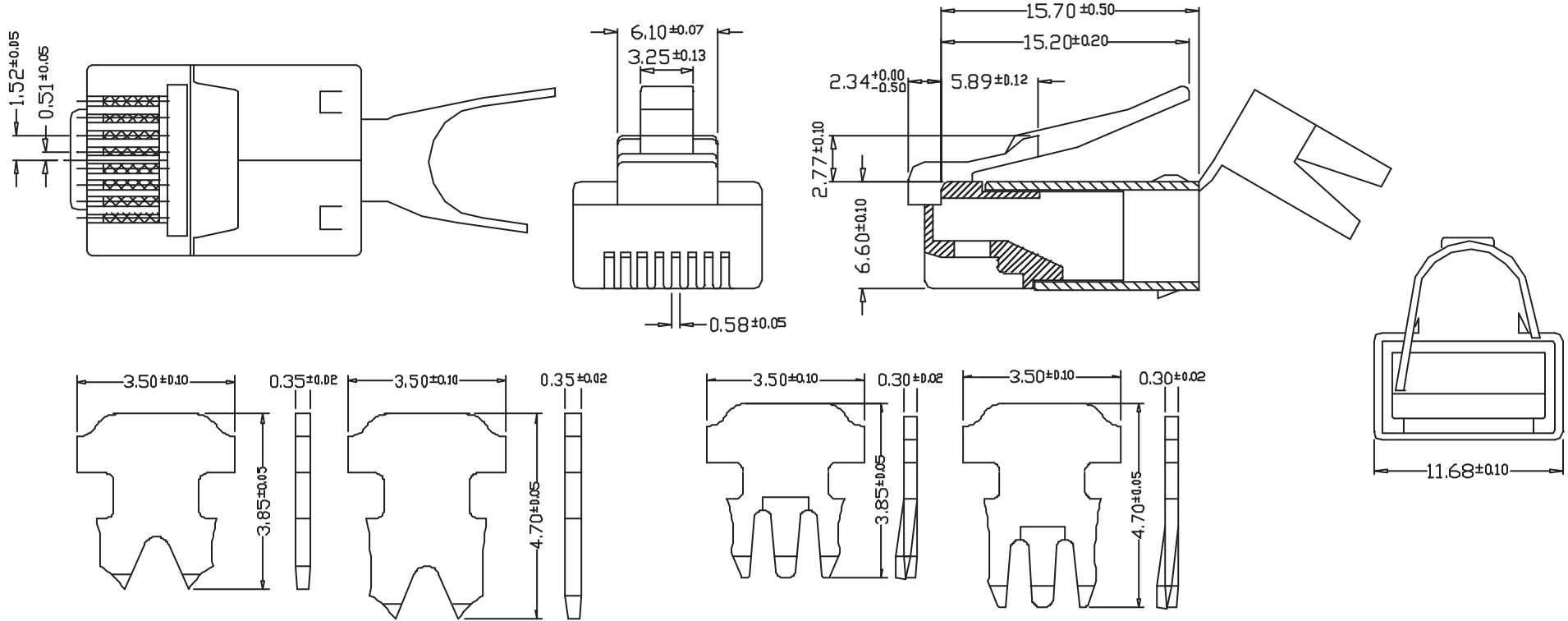

" " : 2 PRONGS FOR STRANDED WIRE

"3" : 3 PRONGS FOR SOLID WIRE(S)

PART NUMBER CODE:

MPSC6 H R 02 U2 **
 1 2 3 4 5

1. NUMBER OF CONTACT
2. R:ROUND CABLE F:FLAT CABLE
3. SKIP:2 PRONGS FOR STRANDED WIRES
 02:2 PRONGS FOR SOLID WIRES
 03:3 PRONGS FOR SOLID WIRES
4. U2:UL94V2, U0:UL-94V0 REATED
5. CONTACT GOLD PLATING:
 03: 3u" 06:6u" , 15:15u", 30:30u" 50:50u"

PANSTRONG COMPANY LTD.				DRAWN BY		TOMMY	
				CHECKED			
TITLE:				APPROVED			
PART NO:		MPSC6H		DRAW NO			
File Number:							
SCALE				REV	A	UNIT	mm

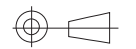

REV	DESCRIPTION	DATE
A	Initial Release	07.09.21

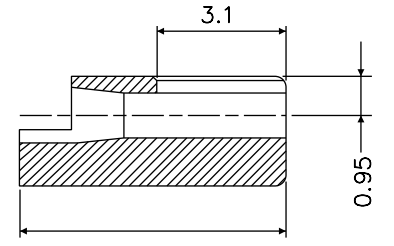
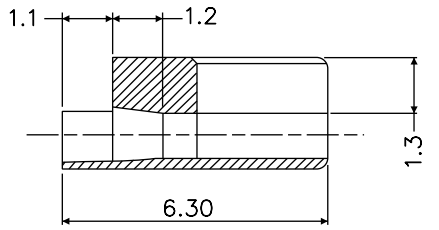
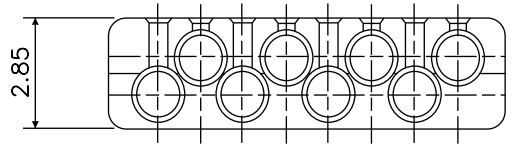
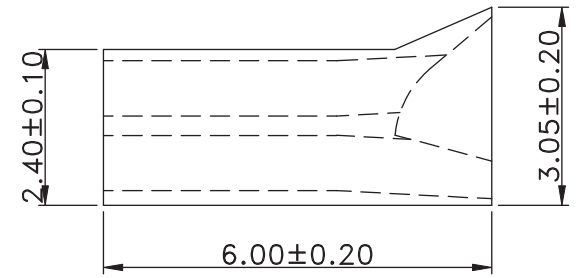
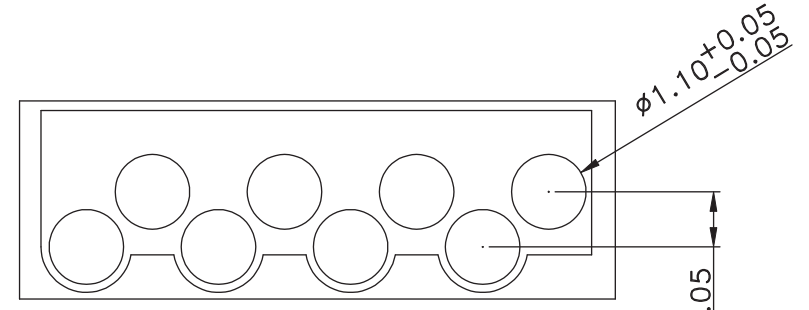
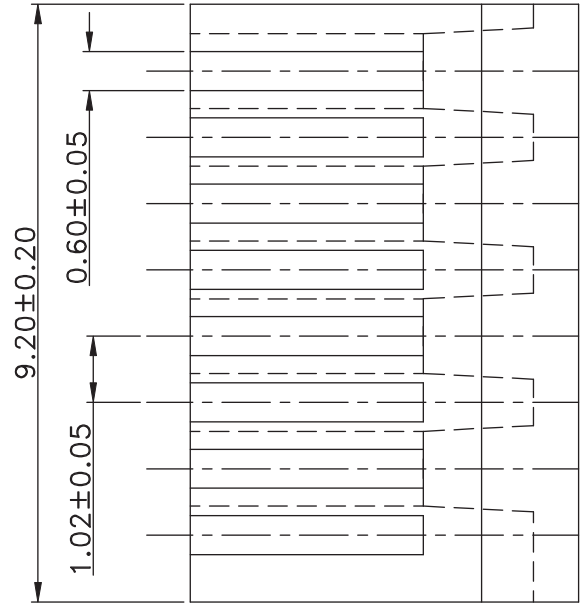
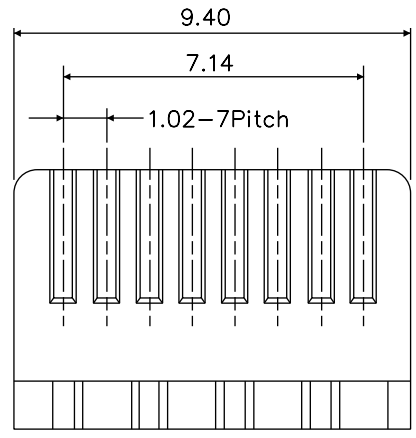

MATERIAL:
1.Housing: Polycarbonate, UL 94V-2
UL 94V-0

 PANSTRONG COMPANY LTD.	DRAWN BY	TOMMY
	CHECKED	
TITLE:		APPROVED
PART NO:	MPSC6H	DRAW NO
File Number:		
SCALE	REV	A
UNIT	mm	