

REV	DESCRIPTION	APPROVAL	DATE
A/0	新制定		07.01.22

PART NO. HS 09 01 G 01 E
 1 2 3 4

- 1. 01:Plastic
03:Metallic
 - 2. K:Black
G:Grey
I: Ivory
C:Nickel Over Plastic
 - 3. 01:Short Screws
02:Long Screws
 - 4. E:RoHS
- Body Material : ABS UL94HB

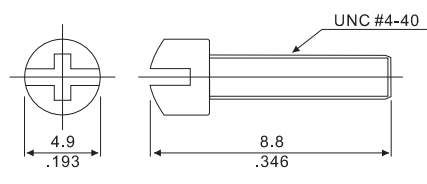
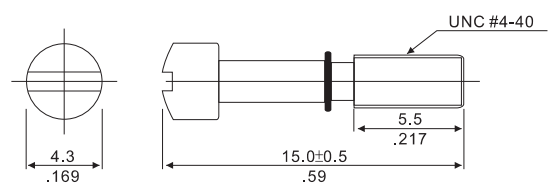
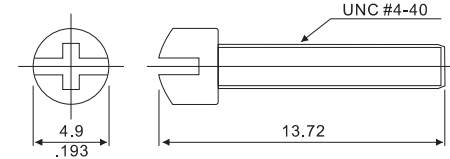
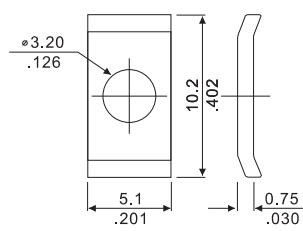
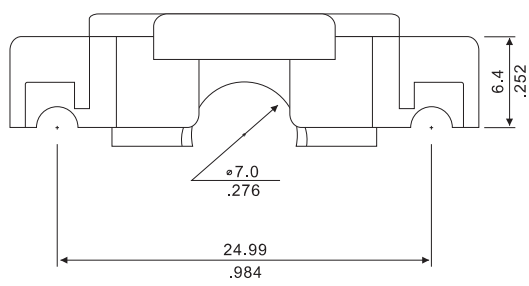
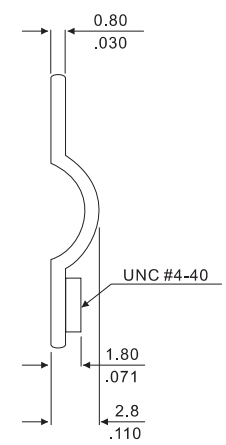
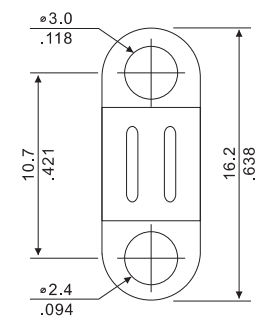
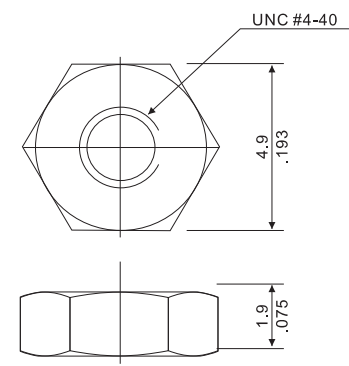
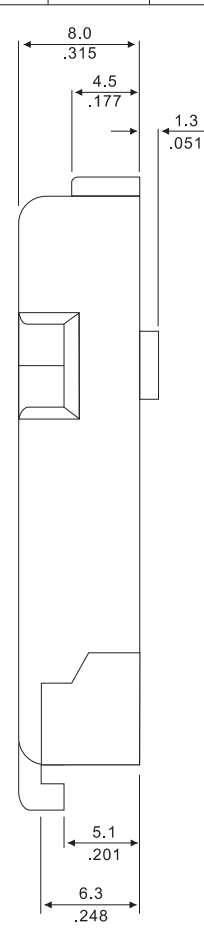
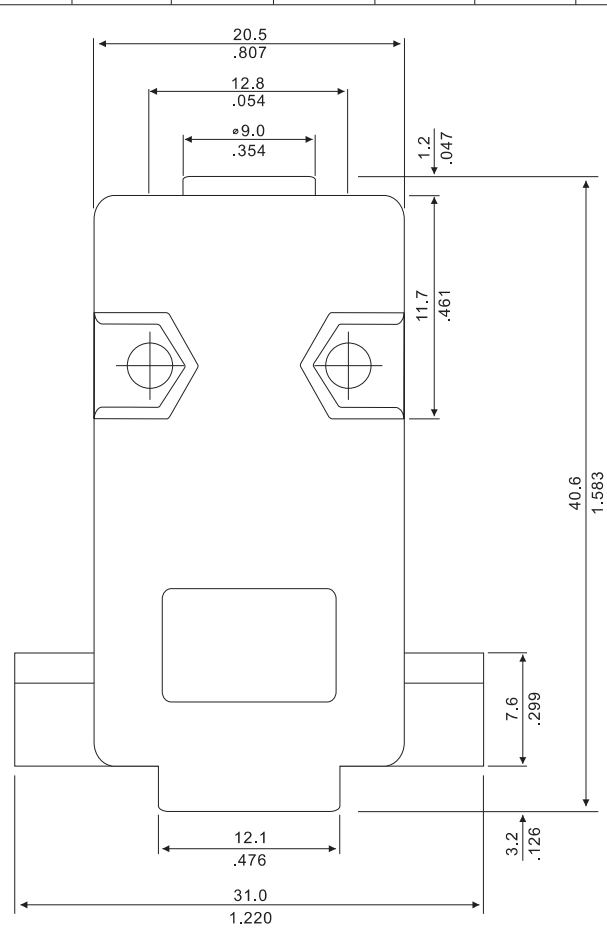

貝強實業有限公司 PANSTRONG COMPANY LTD.	DRAWN BY		TOMMY	
	CHECKED			
	APPROVED			
	DRAW NO			
未標示公差尺寸值 METRIC .0= 0.35 .00= 0.25 .000= 0.15	TITLE:	D-Sub Plastic Hood		
	PART NO:	HS090xx01E		
	DRAW. BOX NO:			
	SCALE	1:1	REV	A/0
	UNIT	mm		