

REV	DESCRIPTION	DATE
A	半包式增加35PIN	09'.08.20
	全包與半包零件料號拆開	10'.06.10
	客戶需求增加Mylar	10'.12.23
	Cover寬度有2種新增區分	11'.01.27
	新增反腳位選項	11'.09.26
	修改軟排尺寸	12'.05.25

SPECIFICATIONS

- Current Rating : 0.4A AC/DC
- Withstanding Voltage : 200V AC/minute
- Insulation Resistance : 500MΩ min.
- Temperature Range : - 25°C to + 85°C
- Contact Resistance : 20mΩ max.
- Material :
 - 1.Contact : Phosphor Bronze ; Mat-Tin Plated
 - 2.Nail : Brass ; Mat-Tin Plated
 - 3.Housing : LCP , Color: Nature
 - 4.Cover : LCP ,Color: Black

FPC CONNECTOR

- Part No. : FP xx -E03SWZA-3 **
- 1 23

1. Contact Positions: 04...60
2. Contact Plating:
 - Blank: Tin
 - G: Flash Gold
3. Package:
 - Blank: TR without Mylar
 - R1: TR with Mylar
 - R2: TR with Wide Pick up Cover

Poles	Dimensions(mm)					Poles	Dimensions(mm)					Poles	Dimensions(mm)				
	A	B	C	D	E		A	B	C	D	E		A	B	C	D	E
04	1.50	7.60	2.60	6.50		24	11.50	17.60	12.60	16.50	4.40	44	21.50	27.60	22.60	26.50	
05	2.00	8.10	3.10	7.00		25	12.00	18.10	13.10	17.00		45	22.00	28.10	23.10	27.00	
06	2.50	8.60	3.60	7.50		26	12.50	18.60	13.60	17.50		46	22.50	28.60	23.60	27.50	
07	3.00	9.10	4.10	8.00		27	13.00	19.10	14.10	18.00		47	23.00	29.10	24.10	28.00	
08	3.50	9.60	4.60	8.50		28	13.50	19.60	14.60	18.50		48	23.50	29.60	24.60	28.50	
09	4.00	10.10	5.10	9.00		29	14.00	20.10	15.10	19.00		49	24.00	30.10	25.10	29.00	
10	4.50	10.60	5.60	9.50		30	14.50	20.60	15.60	19.50		50	24.50	30.60	25.60	29.50	
11	5.00	11.10	6.10	10.00		31	15.00	21.10	16.10	20.00		51	25.00	31.10	26.10	30.00	
12	5.50	11.60	6.60	10.50		32	15.50	21.60	16.60	20.50		52	25.50	31.60	26.60	30.50	
13	6.00	12.10	7.10	11.00		33	16.00	22.10	17.10	21.00		53	26.00	32.10	27.10	31.00	
14	6.50	12.60	7.60	11.50		34	16.50	22.60	17.60	21.50		54	26.50	32.60	27.60	31.50	
15	7.00	13.10	8.10	12.00		35	17.00	23.10	18.10	22.00		55	27.00	33.10	28.10	32.00	
16	7.50	13.60	8.60	12.50		36	17.50	23.60	18.60	22.50		56	27.50	33.60	28.60	32.50	
17	8.00	14.10	9.10	13.00		37	18.00	24.10	19.10	23.00		57	28.00	34.10	29.10	33.00	
18	8.50	14.60	9.60	13.50		38	18.50	24.60	19.60	23.50		58	28.50	34.60	29.60	33.50	
19	9.00	15.10	10.10	14.00		39	19.00	25.10	20.10	24.00	4.90	59	29.00	35.10	30.10	34.00	
20	9.50	15.60	10.60	14.50		40	19.50	25.60	20.60	24.50		60	29.50	35.60	30.60	34.50	
21	10.00	16.10	11.10	15.00		41	20.00	26.10	21.10	25.00							
22	10.50	16.60	11.60	15.50		42	20.50	26.60	21.60	25.50							
23	11.00	17.10	12.10	16.00		43	21.00	27.10	22.10	26.00							

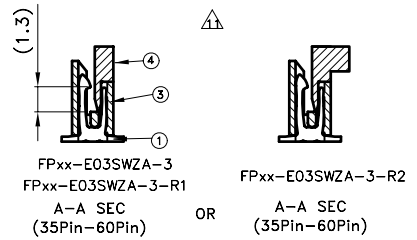
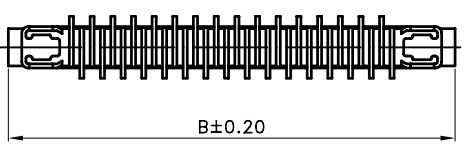
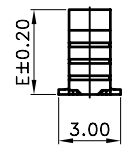
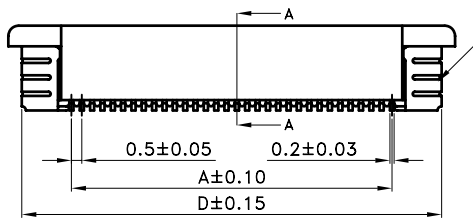
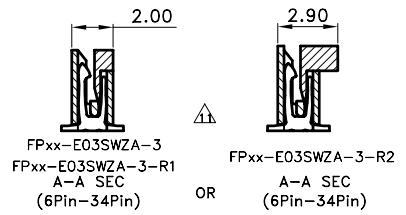
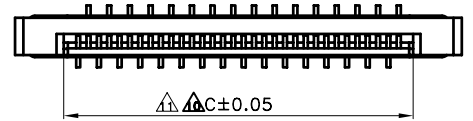
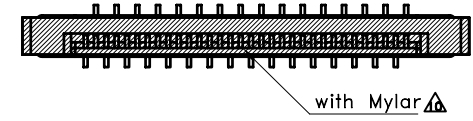
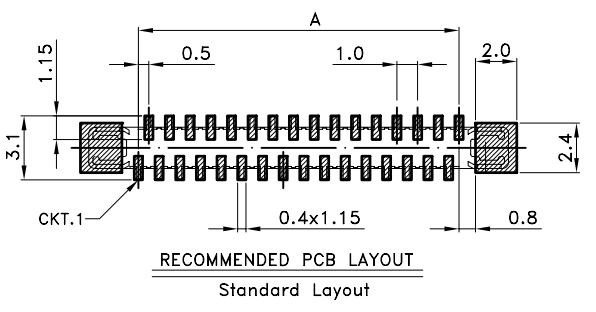
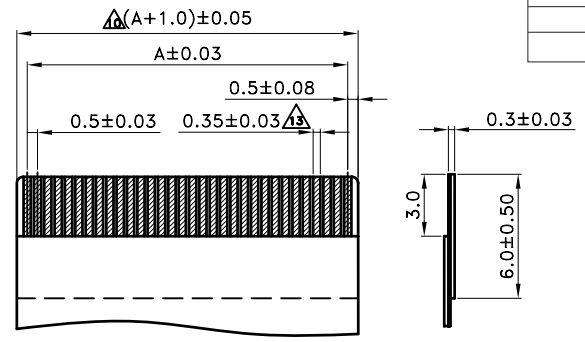
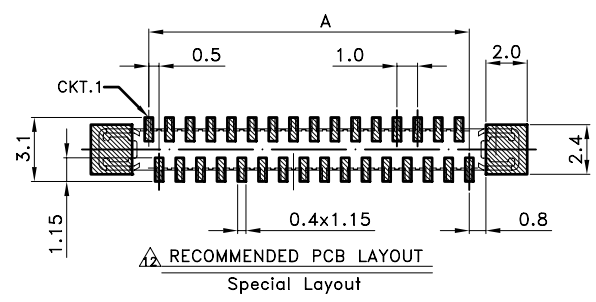

TOLERANCE	
∅	±0.30
.00	±0.20
.000	±0.10
ANGLE	
0°	±1°
∅	±

PANSTRONG COMPANY LTD.

TITLE: 0.5mm Pitch ZIF FPC SMT Straight Type Connector

PART NO.: FPxx-E03SWZA-3

SCALE: /

REV: A

DRAWN BY: TOMMY

CHECKED:

APPROVED:

DRAWING NO.: JS-1191VX-XXXX

UNIT: mm