

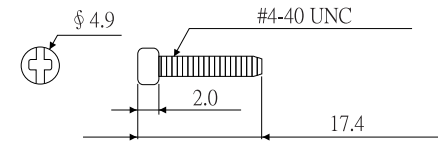

REV	DESCRIPTION	APPROVAL	DATE
A	新制定		06.06.14

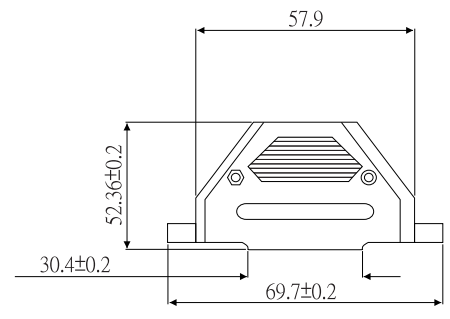

Material:
 Insulator: ABS UL94-HB
 Color:
 X= G: Gray
 X= K: Black
 X= C: Nickel Plated
 Metal Parts : Steel/Nickel plated

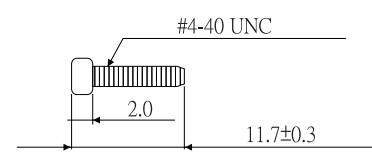
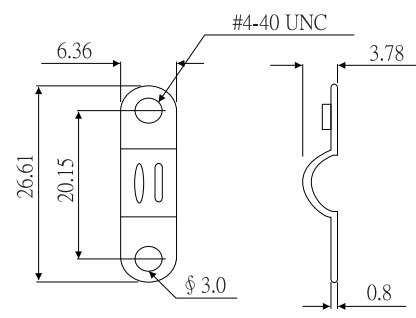
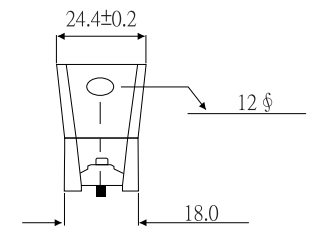
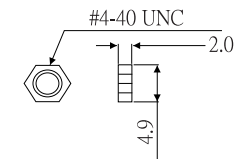
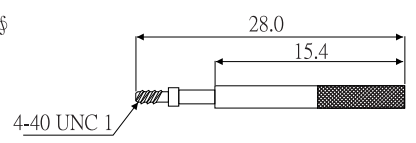
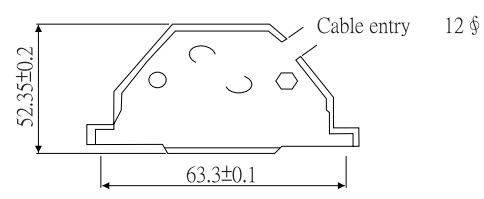

PART NO:
 HS3701x02R1: PLASTIC
 HS3703C02R1: PLASTIC CHROMATED (METALLIC)

 貝強實業有限公司 PANSTRONG COMPANY LTD.	DRAWN BY	TOMMY
	CHECKED	
TITLE:	D-Sub Metalloid Hood	
PART NO:	H3703C01-R1	
DRAW. BOX NO:		
SCALE	REV	A
UNIT	mm	